

CS-710/720/730/740

interM

COLUMN SPEAKER(INDOOR USE)

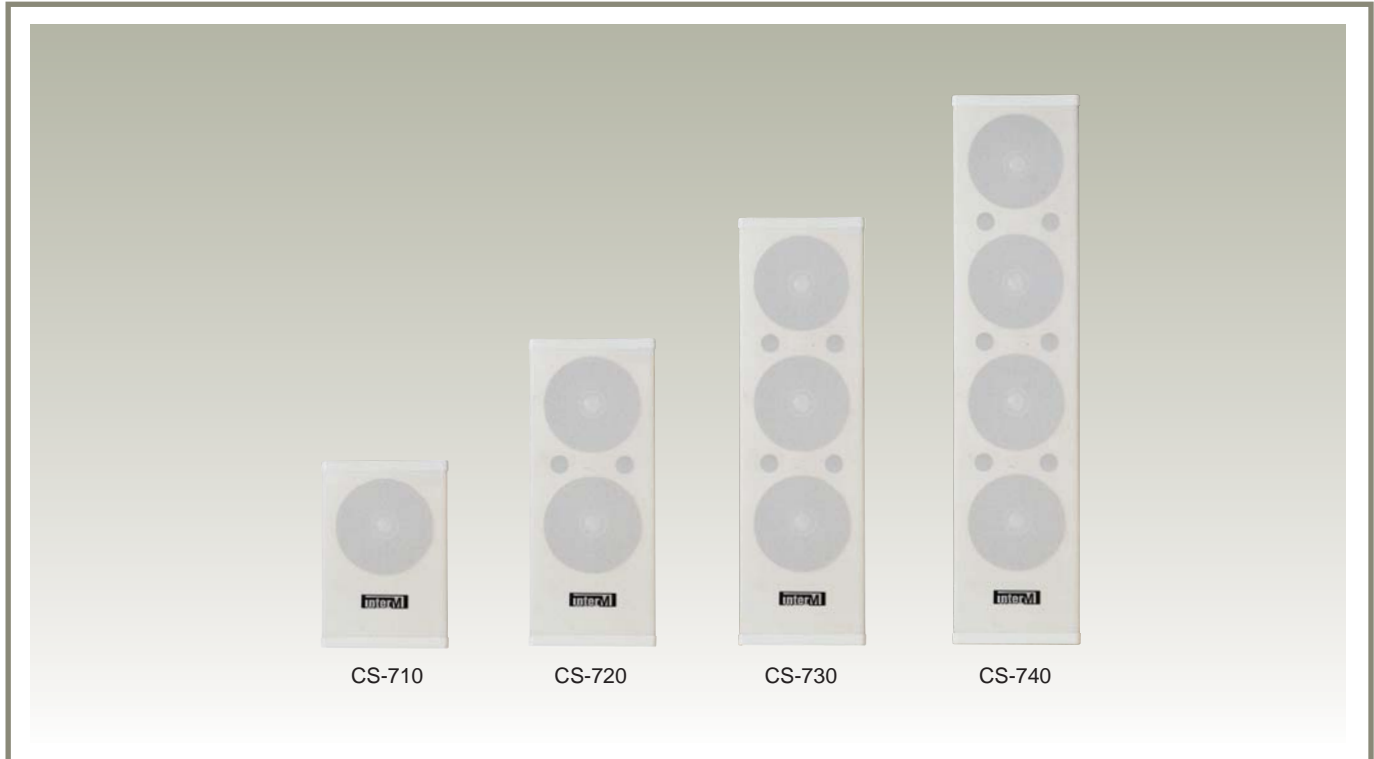

FEATURES

- **INDOOR USE**
These column speakers are designed for indoor use.
- **LONG LIFE**
You can use these long time, why these are designed with aluminum alloy and painted for anti-rust.
- **HIGH EFFICIENCY FOR P.A**
Full range speaker unit and matching transformer are incorporated for high efficiency of P.A.
- **EASY INSTALLATION**
With instrument, you can install it easily by using provided bracket.

SPECIFICATIONS

spec \ model	Unit	CS-710	CS-720	CS-730	CS-740
Rated Input	W	10	20	30	40
Frequency Response	HZ	200-14k	200-14k	200-14k	200-14k
Impedance	Ω	1k/2k	500/1k	330/660	250/500
S.P.L 1m/1W	dB	88	90	91	93
Material of Case		Aluminum			
Weight	kg	1.6	2.9	3.8	4.6
Dimensions(W×H×D)	mm	138×253×105	138×326×105	138×453×105	138×580×105

MOUNTING METHOD

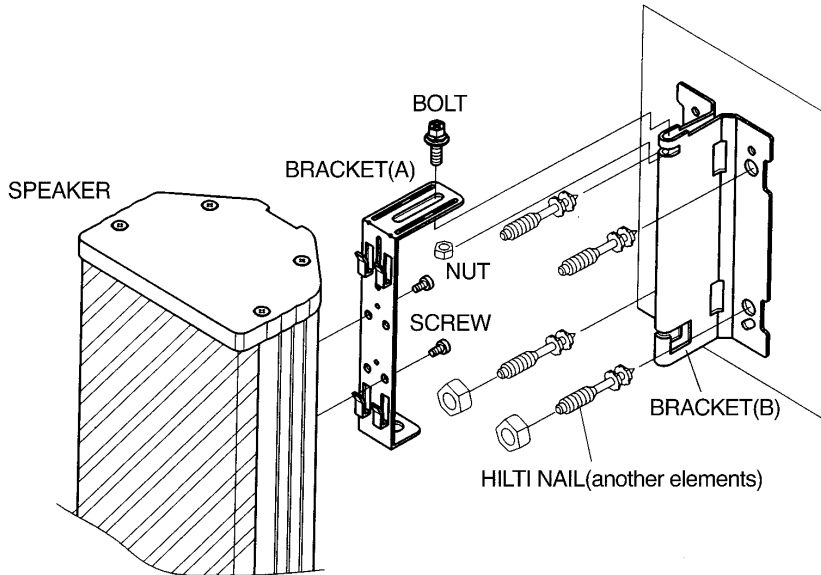

TERMINAL CONNECTION/DUAL CHANNEL ANALYZER GRAPHICS

CS-710

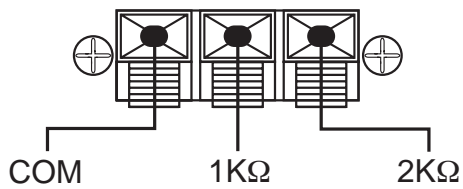

Terminal Connection

CS-720

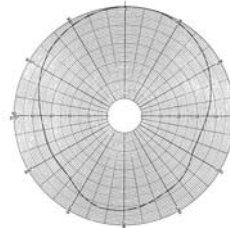

Horizontal

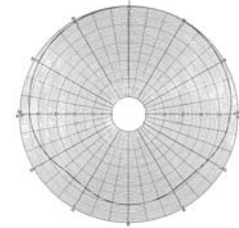

Vertical

CS-730

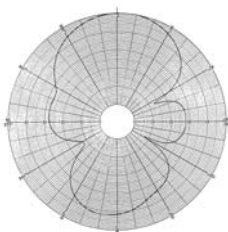

Horizontal

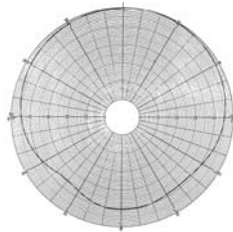

Vertical

CS-740

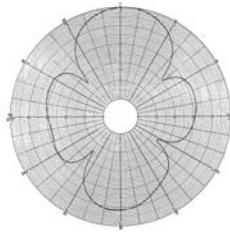

Horizontal

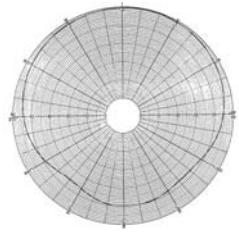

Vertical

interM

OFFICE : 653-5 BANGHAK-DONG, DOBONG-KU, SEOUL, KOREA TEL : 82-2-2289-8140~8, FAX : 82-2-2289-8149

Home page : <http://www.inter-m.com>

E-mail : export@inter-m.com

9047902241